

**HUSTED**

EMBALLAGE

# Papkasseguiden

sådan finder du den rigtige kasse



Markedet tilbyder en række forskellige typer emballage og papkassemodeller til forskellige anvendelser og formål. Vi hjælper dig med at finde den rigtige model til netop dine behov! Her viser vi de mest almindelige konstruktioner i vores sortiment; de standardiserede FEFCO-modeller og også vores egne tilpassede modeller.

FEFCO-koden er det internationale system til gruppering af bølgepapemballage. Den indeholder modeller af de mest almindelige kassetyper med en kode for hver konstruktion, med det formål at gøre det enkelt for alle, der arbejder i bølgepapbranchen. FEFCO-systemet gør det nemt at skelne mellem forskellige konstruktioner.

FEFCO-koderne beskriver konstruktionen og de to første cifre i koden viser hvilken kategori af kasser den tilhører.

- 01 – Ark og enkeltsidet bølgepap
- 02 – Slidsede kasser, omslag og andre æsker lavet i ét stykke.
- 03 – Teleskop emballage
- 04 – Stansede kasser og omslag
- 05 – Skub- og trækkasser
- 06 – Trekomponentsemballage
- 07 – Færdiglimet emballage
- 08 - Detailhandel og e-handelsemballage
- 09 – Indretning i papkasser

Vores egne kassemodeller er navngivet med MA, MB o.s.v.  
Vi kan naturligvis hjælpe dig med flere modeller eller skræddersyede løsninger.

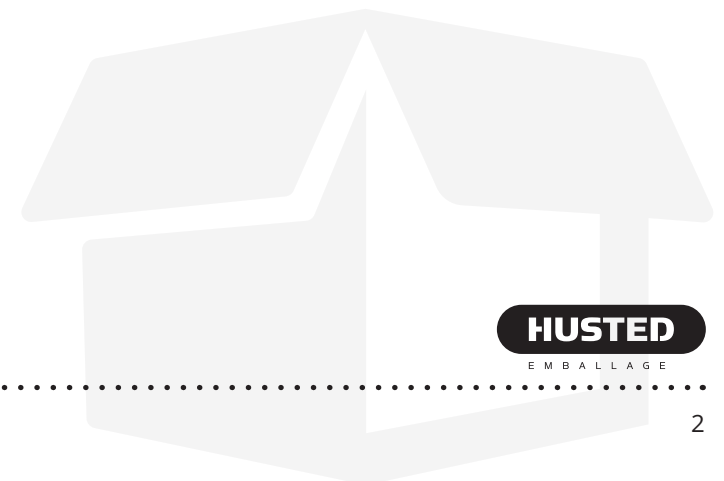

## 02 - Slidsede kasser

Slidsede kasser er et foldbart bølgepap lavet i ét stykke. Slidsede kasse samles med lim, tape eller hæftning. Slidsede kasser leveres fladt (plano).

### 0201 – Slidset kasse

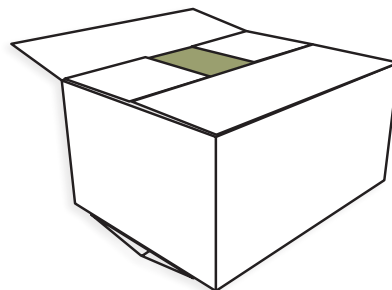
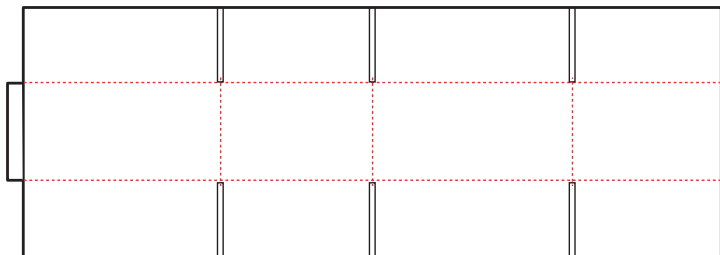

### 0201-0203 – Slidset kasse med fuld overlap

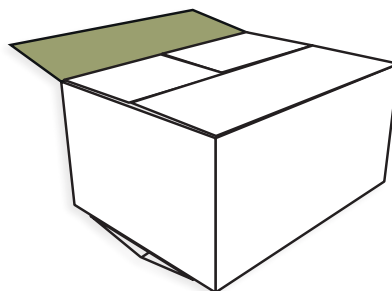
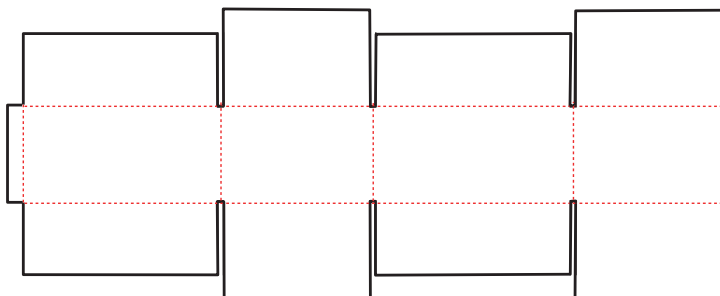

#### 0203 - Slidset kasse med fuld overlap

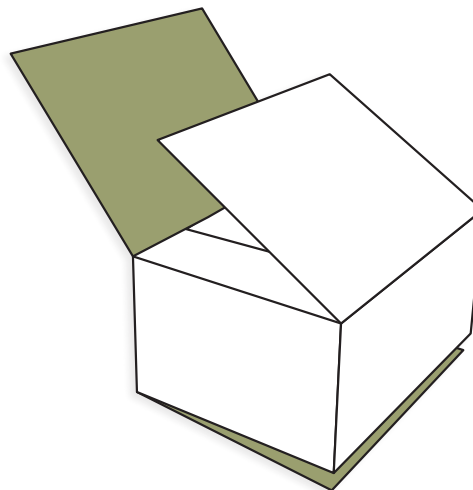
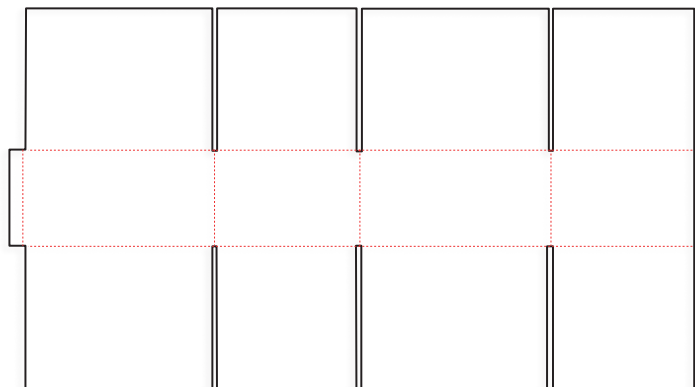

#### 04 - Stansede kasser og omslag

Udstansede kasser er normalt altid selvlåsende og kræver ikke sammenføjning med f.eks. tape eller lim. Konstruktionen er stabil og opbygget i ét stykke. Omslag kræver lukning med tape eller lignende og er en god løsning til f.eks. bøger.

#### 0401 - Flexibelt omslag

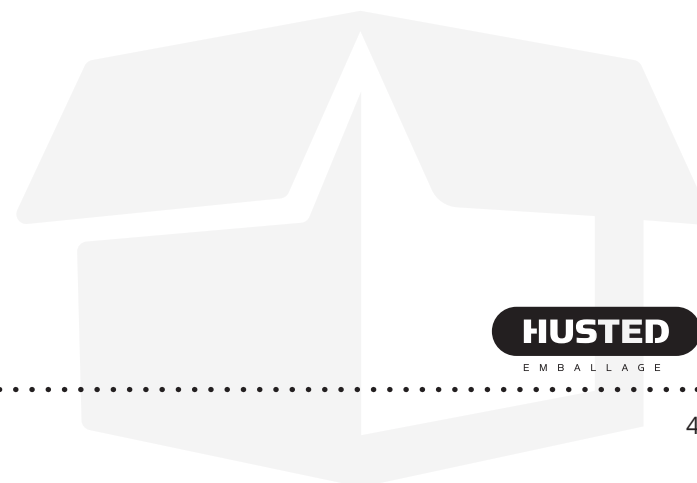
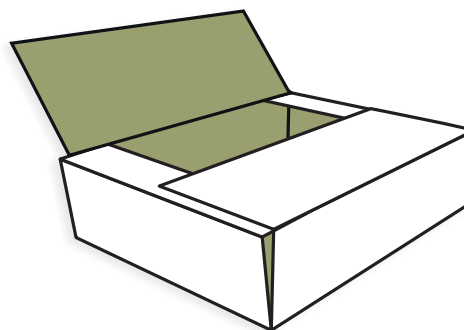
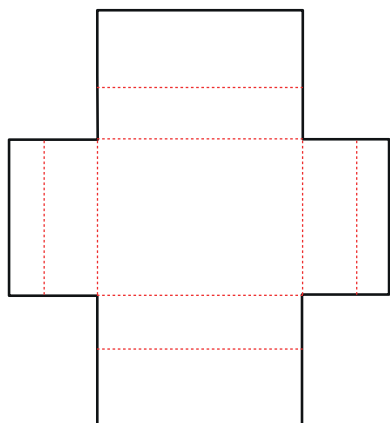

0409 - Omslag, 5-sidet

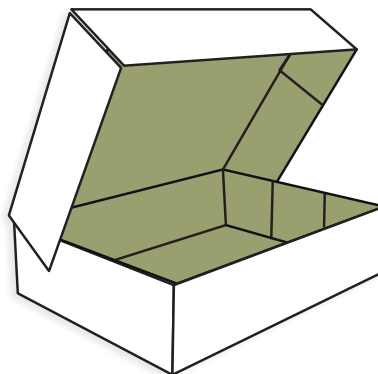
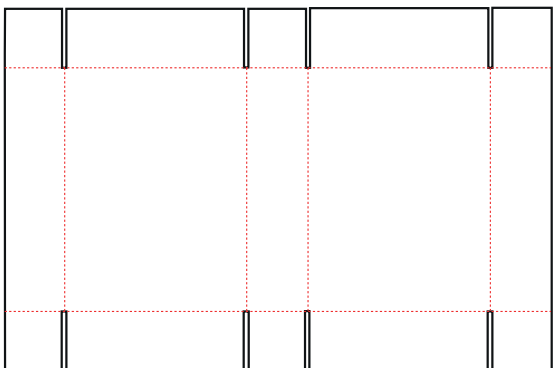

0421 - Selvlåsende kasse med låg

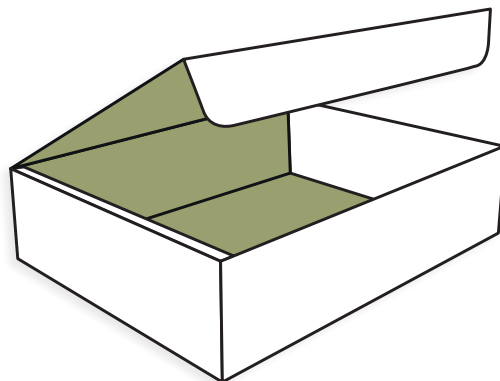
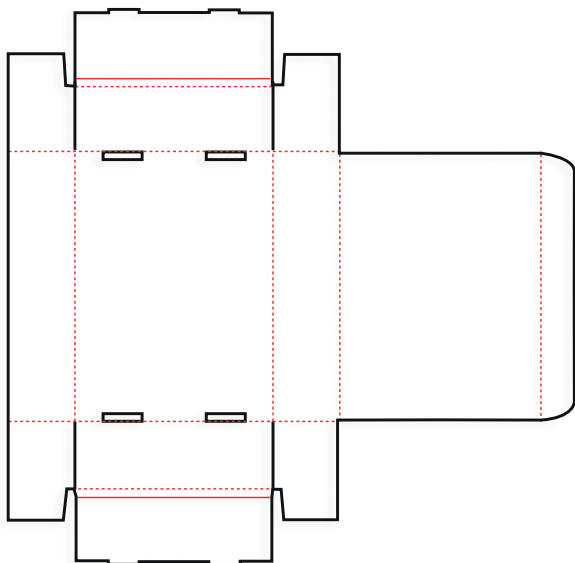

0422 - Selvlåsende bakke

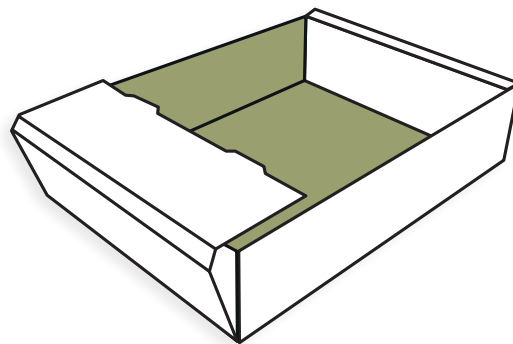
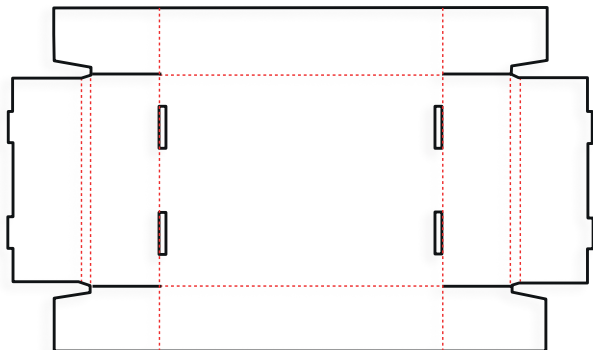

0426 - Selvlåsende kasse

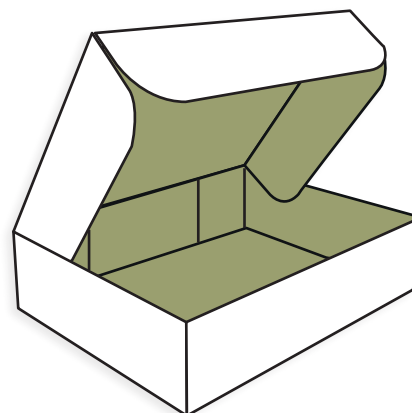
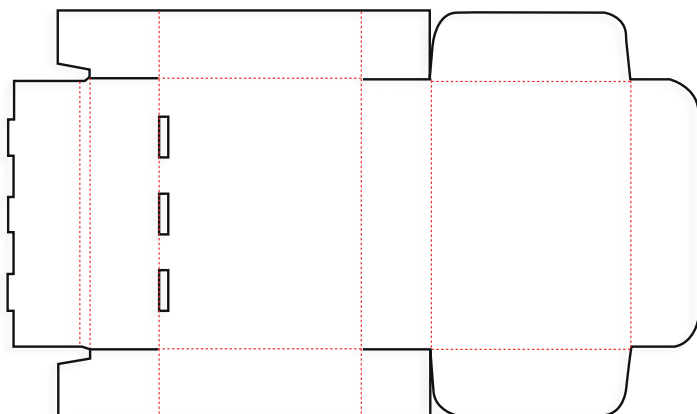

0427 - Selvlåsende kasse med låseflap

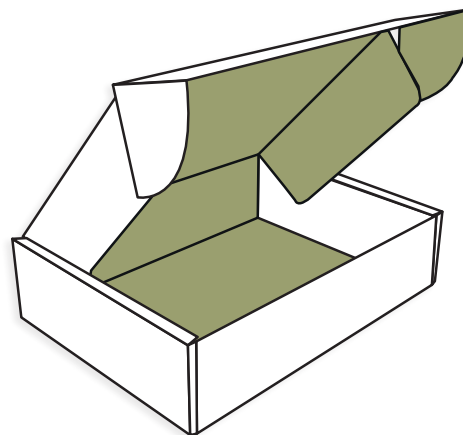
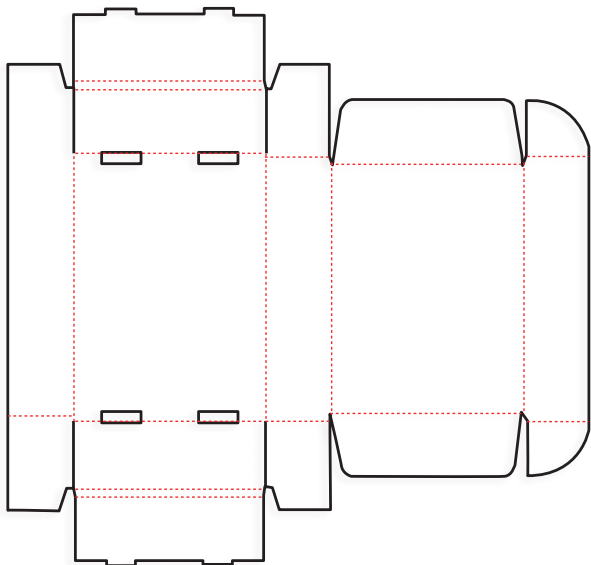

0429 - Selvlåsende kasse

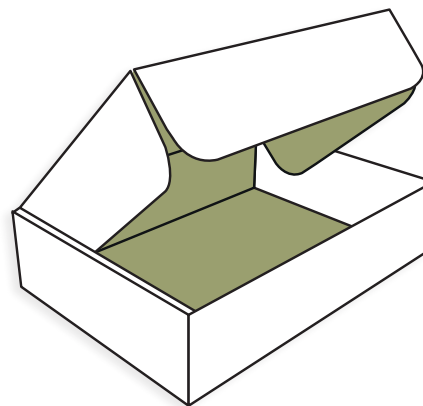
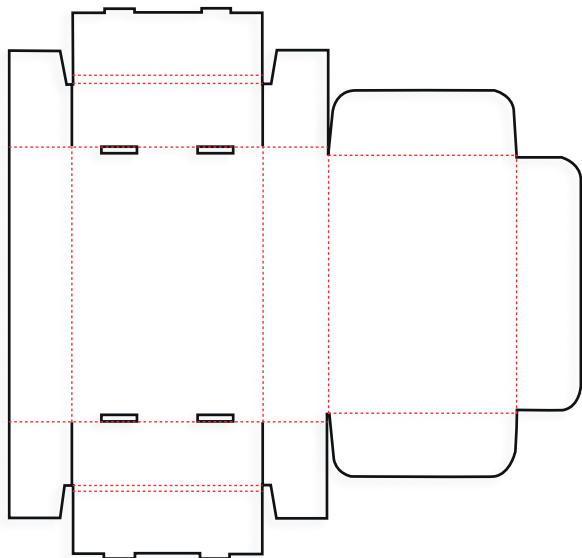

## 0470 - Selvlåsende kasse

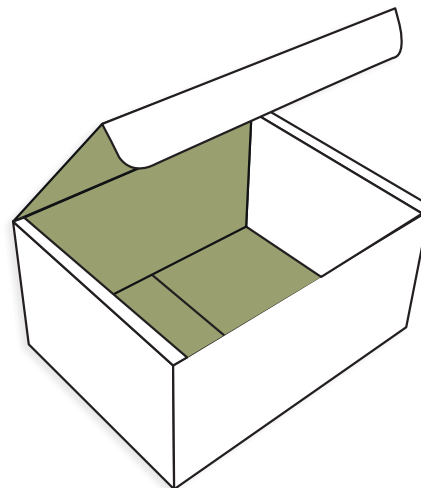
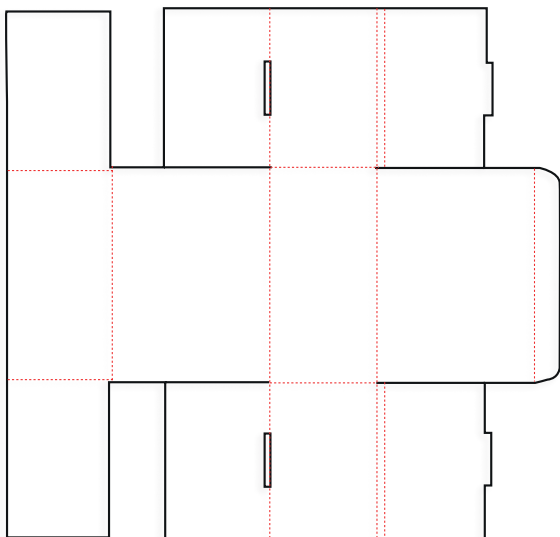

## 05 - Omslag

Omslag består normalt af flere konstruktionsstykker, der skubbes i hinanden. Denne gruppe omfatter også yderomslag til andre kasser.

### 0501 - Omslag uden bund og låg

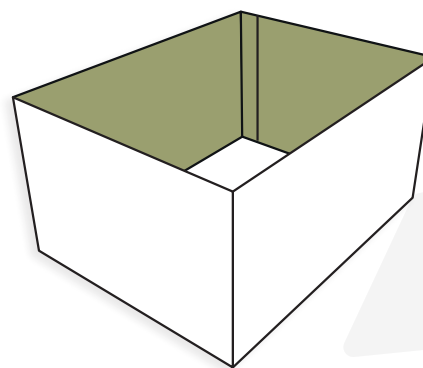



## 07 - Færdiglimet emballage

Smarte æsker der er lavet i ét stykke. Leveres fladt og samles nemt og hurtigt.  
Sparer pakketid!

### 0701 - Hurtigbund kasse

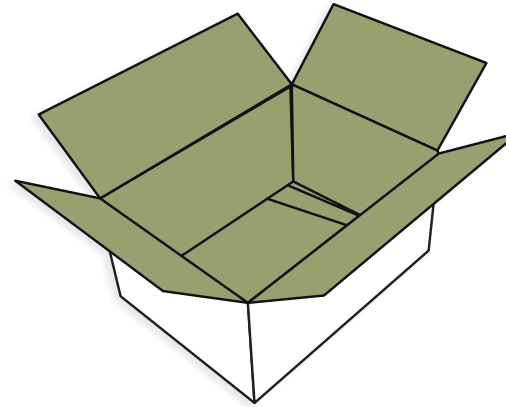
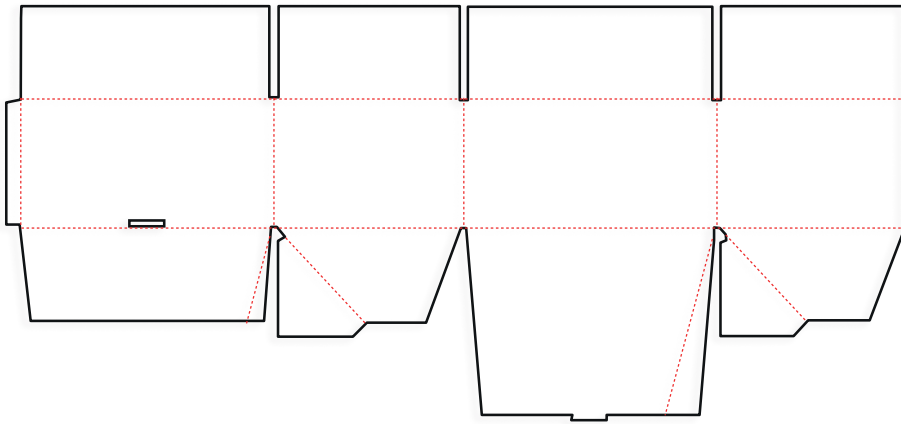

### 0711 - Hurtigbund kasse

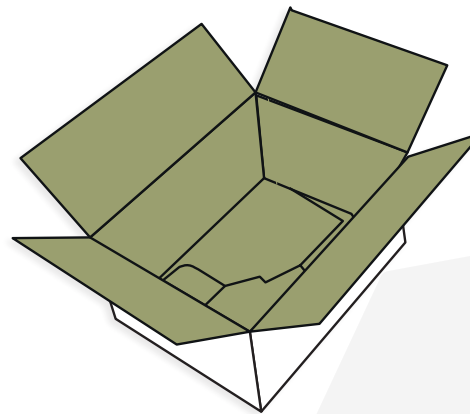
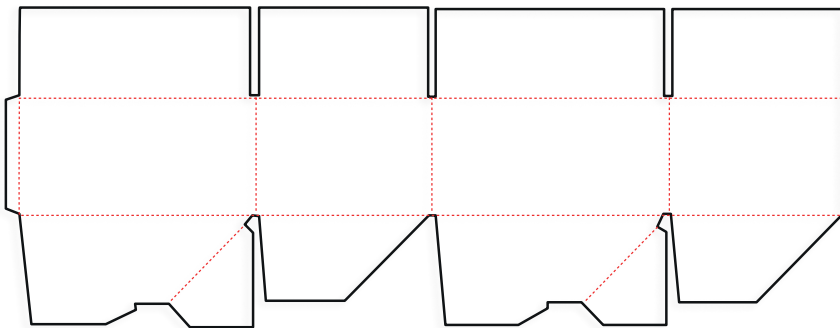

MB1 – Selvläsande kasse

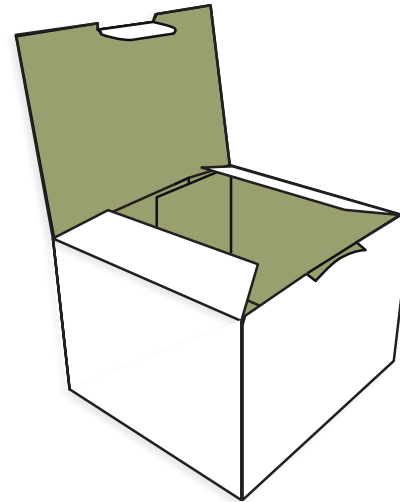
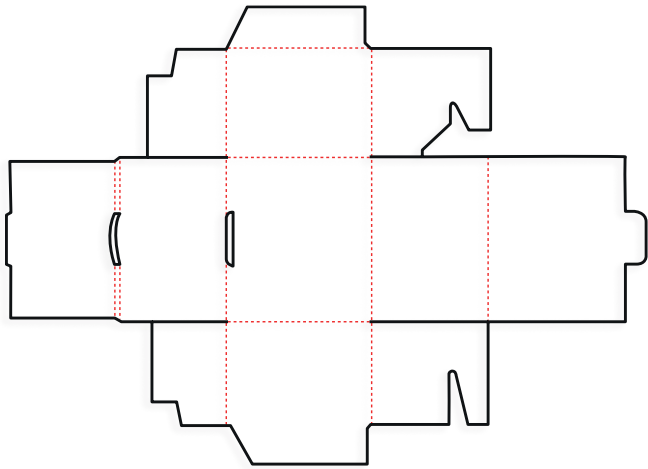

MB2 – Selvläsande kasse

